



Distagon T* 2,8/25



Features

- f/2.8 aperture
- Precise manual focusing
- Robust full-metal construction
- Identical color reproduction of all models
- For industrial cameras with F-Mount up to sensor sizes of 24x36 mm or 43mm line sensors.
- Very short free working distance (60 mm)

ZF-I: Industrial Edition

Features special screws to fix focus and aperture settings even in rough situations.

ZF-IR: Infrared Edition

Features special coating for optimized performance in near-infrared applications.

Camera Mounts

Available for other camera mounts such as EF, or M42 screw mount.



Distagon T* 2,8/25

Technical Specifications

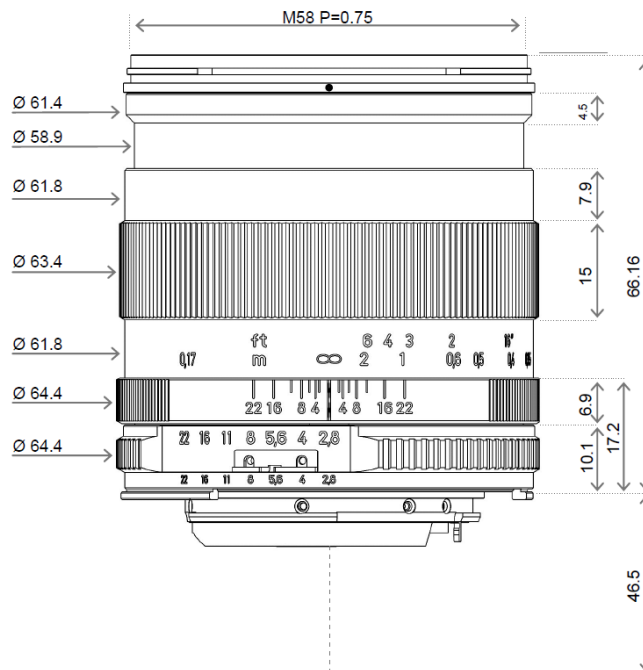

Focal length	25 mm
Aperture range	f/2.8 – f/22 (1/ 2 stop intervals)
Number of elements / groups	10 / 8
Min. working distance (object to sensor)	170 mm (0.56 ft.) – ∞
Min. free working distance	60 mm (0.20 ft.) – ∞
Angular field* (diag. / horiz. / vert.)	80 / 70 / 50°
Max. diameter of image field	43 mm (1.7")
Flange focal length	F-Mount: 46.5 mm (1.8"); M42-Mount: 45,5 mm
Coverage at close range	55 x 83 mm (2.17 x 3.27"), line 98mm (3.8")
Image ratio at close range	1:2.3
Filter-thread	M 58 x 0.75
Weight	460 g (0.92 lbs)
Camera mount	F bayonet, M42, EF

* referring to 35 mm format



Distagon T* 2,8/25

Relative Illuminance*

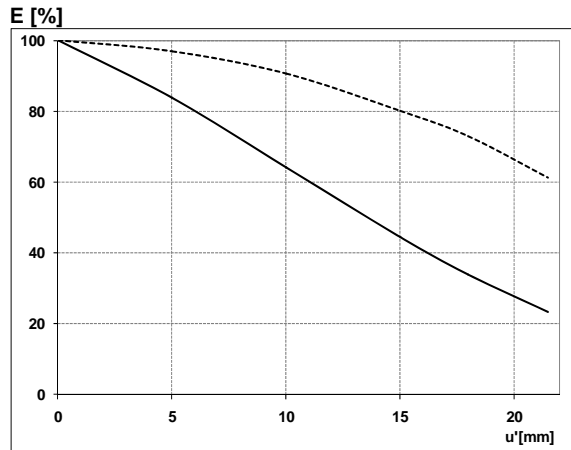

The relative illuminance shows the decrease in image brightness from the image center to the edge in percent.

— f-number 2.8
... f-number 5.6

Relative Distortion*

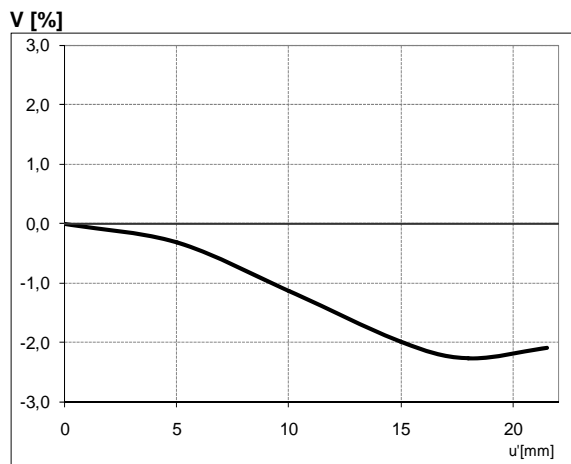

The relative distortion shows the deviation of the actual image height from the ideal one in percent.

**Data for infinite focus setting*



Distagon T* 2,8/25

MTF Charts*

MTF [%] k=2.8

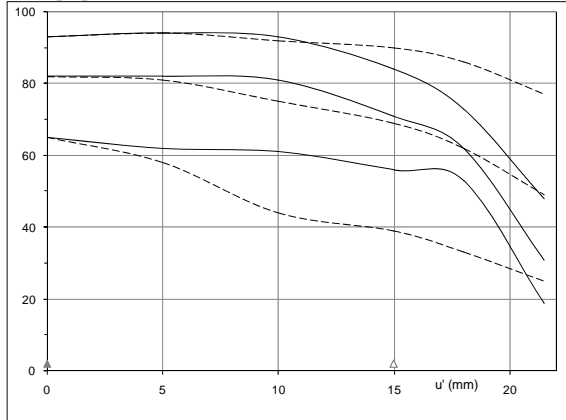

The Modulation Transfer (MTF) as a function of image height (u') and slit orientation (sagittal, tangential) has been measured with white light at spatial frequencies of $R = 10, 20$ and 40 cycles/mm. The MTF charts are valid for the ZF, ZF-I version and for white light.

f-number 2.8
— Saggital
... Tangential

MTF [%] k=5.6

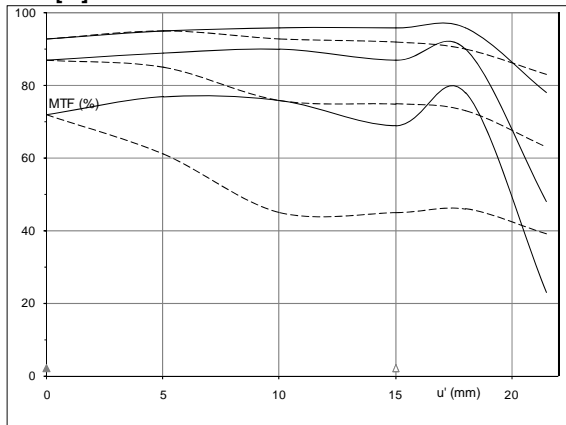

f-number 5.6
— Saggital
... Tangential

*Data for infinite focus setting / Not for IR version



Distagon T* 2,8/25

Spectral Transmission ZF vs. ZF-IR

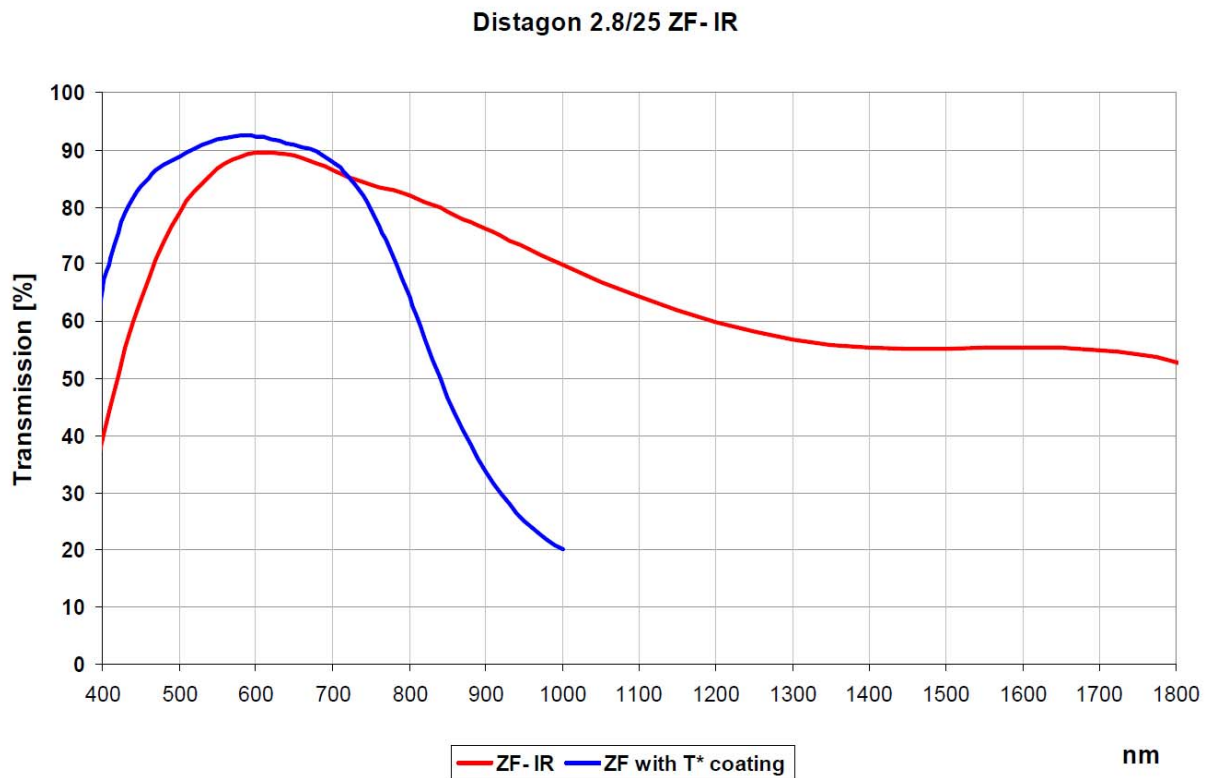



Distagon T* 2,8/25

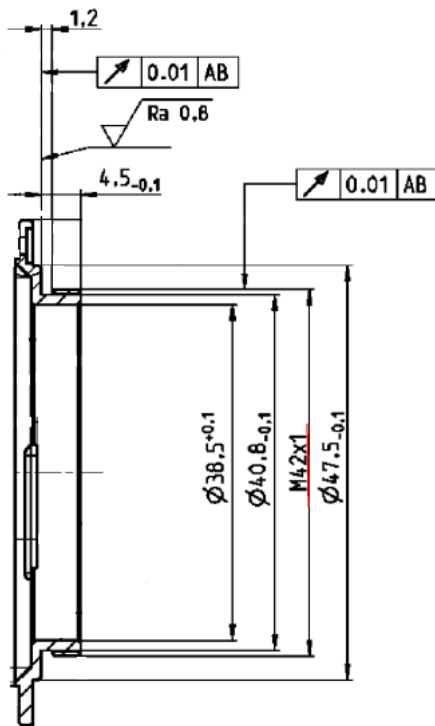

M42 Mount for 45,5 mm Flange Focal Distance

The diameter of the camera/lens adapter must not exceed 55 mm at the lens side!