

Spot Light Illumination

SL-i Series

Innovative LED lighting
for machine vision



Spot lightings with integrated controller
in various colors and angles

- Powerfull light
- Compact design
- High Quality
- Made in Germany

These lightings are made for manifold bright field application. Due to the 4-die LED emitter technology the lighting generates a powerfull spot, available in various angles, with very high intensity made for distant installation in narrow spaces. The new flexible controller concept allows an easy adaptation to different operation modes.

Spot Light Illumination

SL-i Series

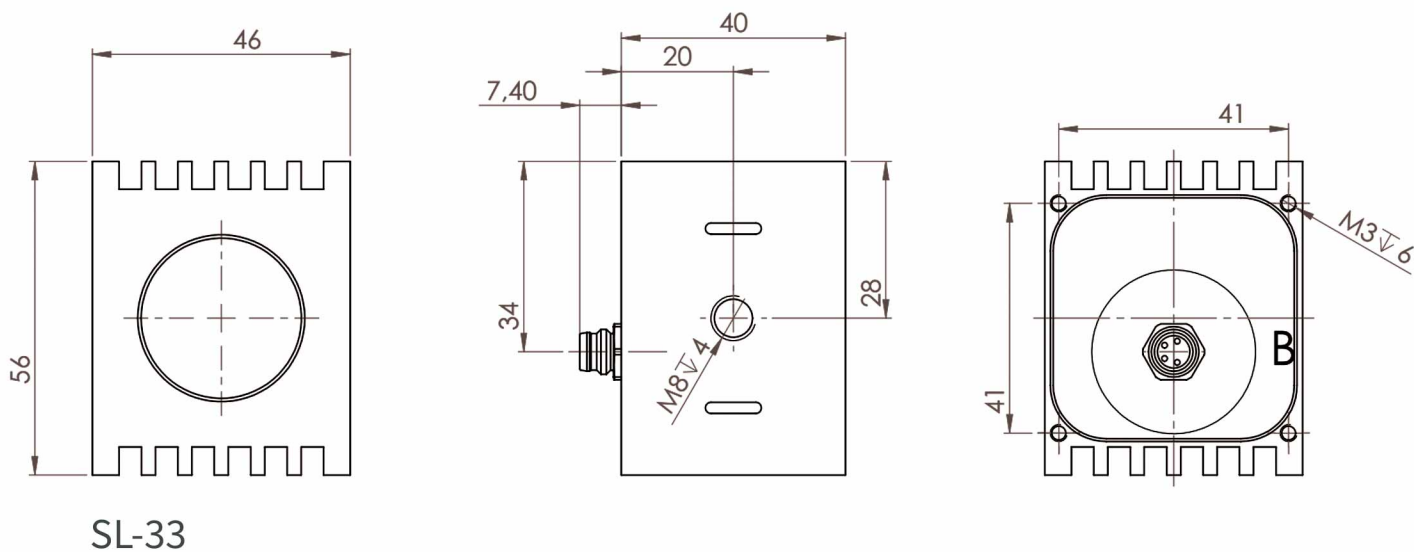

SL-33

Specification

Supply voltage	24 V DC +/- 10%
Spot angle	Wide (33°), medium (26°), narrow (22°)
Connection	M8 male connector with 4 pin
Accessories	1/4-inch adapter; adjustable ball point bracket
IP Rating	IP65
Operation conditions	Temperature 10° to 30°C, humidity 30% to 70%

Color ¹ / Model	Wide	Medium	Narrow	Wavelength	Price ²
Cool White	SL-33-WT	SL-26-WT	SL-22-WT	-	240 €
Blue	SL-33-BE	SL-26-BE	SL-22-BE	457nm	270 €
Green	SL-33-GN	SL-26-GN	SL-22-GN	523nm	270 €
Red	SL-33-RD	SL-26-RD	SL-22-RD	623nm	270 €
Infrared	SL-33-IR	SL-26-IR	SL-22-IR	850nm	270 €

1) On request: warm white, 660nm, 740nm, 940nm, 590nm 2) Price plus VAT, packaging and transportation costs

Operation Modes ¹	Mode description	Price ²
(standard)	24V steady light, intergrated current source	+ 0 €
(-x)	External LED control only	- 20 €
(-i)	24V fast flash light, integrated voltage controller	+ 20 €
(-jb)	24V overdrive flash and steady light with dimmer	+ 20 €
Features	Automatic current Rsense detection for (standard) an (- x) models	

1) Some models do not support all operations modes. Please refer to the manual 2) Adaptation to the models base price